



IL205AT/206AT/207AT/208AT

Phototransistor Small Outline Surface Mount Optocoupler

FEATURES

- **High Current Transfer Ratio,**
 $I_F=10\text{ mA}$, $V_{CE}=5.0\text{ V}$
IL205AT, 40–80%
IL206AT, 63–125%
IL207AT, 100–200%
IL208AT, 160–320%
- **High BV_{CEO} , 70 V**
- **Isolation Test Voltage, 3000 V_{RMS} , 1 s**
- **Industry Standard SOIC-8A Surface Mountable Package,**
- **Standard Lead Spacing, .05"**
- **Compatible with Dual Wave, Vapor Phase and IR Reflow Soldering**
- **Underwriters Lab File #E52744 (Code Letter Y)**
- **VDE 0884 Available with Option 1**

DESCRIPTION

The IL205AT/206AT/207AT/208AT are optically coupled pairs with a Gallium Arsenide infrared LED and a silicon NPN phototransistor. Signal information, including a DC level, can be transmitted by the device while maintaining a high degree of electrical isolation between input and output. This family comes in a standard SOIC-8A small outline package for surface mounting which makes them ideally suited for high density applications with limited space. In addition to eliminating through-holes requirements, this package conforms to standards for surface mounted devices.

A specified minimum and maximum CTR allows a narrow tolerance in the electrical design of the adjacent circuits. The high BV_{CEO} of 70 volts gives a higher safety margin compared to the industry-standard 30 volts.

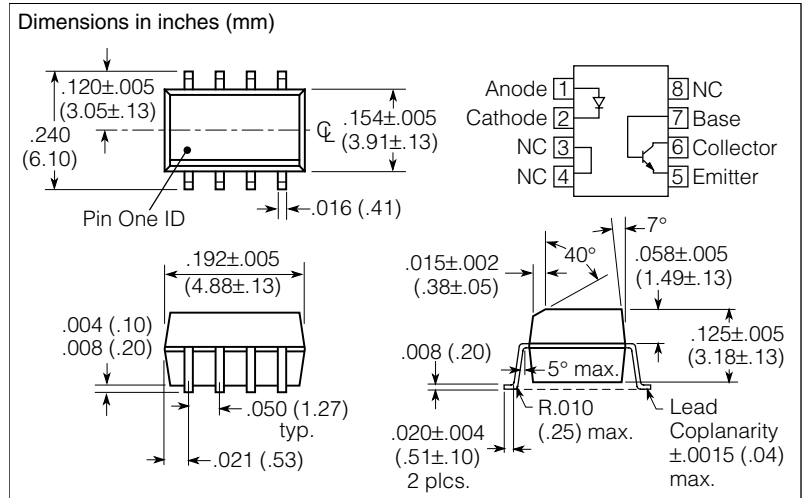

Maximum Ratings, $T_A=25^\circ\text{C}$ (except where noted)

Emitter

Peak Reverse Voltage	6.0 V
Continuous Forward Current	60 mA
Power Dissipation at 25°C	90 mW
Derate Linearly from 25°C	1.2 mW/°C

Detector

Collector-Emitter Breakdown Voltage	70 V
Emitter-Collector Breakdown Voltage	7.0 V
Collector-Base Breakdown Voltage	70 V
I_{CMAX} DC	50 mA
I_{CMAX} ($t < 1.0$ ms)	100 mA
Power Dissipation	150 mW
Derate Linearly from 25°C	2.0 mW/°C

Package

Total Package Dissipation at 25°C Ambient (LED + Detector)	240 mW
Derate Linearly from 25°C	3.3 mW/°C
Operating Temperature	-55°C to +100°C
Storage Temperature	-55°C to +150°C
Soldering Time at 260°C	10 s

Characteristics, $T_A=25^\circ\text{C}$

Parameter	Sym.	Min.	Typ.	Max.	Unit	Condition	
Emitter							
Forward Voltage	V_F	—	1.3	1.5	V	$I_F=10\text{ mA}$	
Reverse Current	I_R	—	0.1	100	μA	$V_R=6.0\text{ V}$	
Capacitance	C_O	—	13	—	pF	$V_R=0$	
Detector							
Breakdown Voltage	BV_{CEO}	70	—	—	V	$I_C=100\ \mu\text{A}$	
	BV_{ECO}	7.0	10	—		$I_E=100\ \mu\text{A}$	
Leakage Current, Collector-Emitter	I_{CEO}	—	5.0	50	nA	$V_{CE}=10\text{ V}$	
Package							
DC Current Transfer	IL205AT	CTR_{DC}	40	—	80	%	$I_F=10\text{ mA}, V_{CE}=5.0\text{ V}$
	IL206AT		63	—	125		
	IL207AT		100	—	200		
	IL208AT		100	—	320		
DC Current Transfer	IL205AT	CTR_{DC}	13	25	—	%	$I_F=1.0\text{ mA}, V_{CE}=5.0\text{ V}$
	IL206AT		22	40	—		
	IL207AT		34	60	—		
	IL208AT		56	95	—		
Saturation Voltage, Collector-Emitter	V_{CEsat}	—	—	0.4	—	$I_C=2.0\text{ mA}, I_F=10\text{ mA},$	
Isolation Test Voltage	V_{IO}	3000	—	—	V_{RMS}	—	
Equivalent DC, Isolation Voltage	—	3535	—	—	VDC	—	
Capacitance, Input to Output	C_{IO}	—	0.5	—	pF	—	
Resistance, Input to Output	R_{IO}	—	100	—	Ω	—	
Switching Time	t_{ON}, t_{OFF}	—	3.0	—	μs	$I_C=2.0\text{ mA}, R_L=100\ \Omega, V_{CC}=10\text{ V}$	

Figure 1. Forward voltage vs. forward current

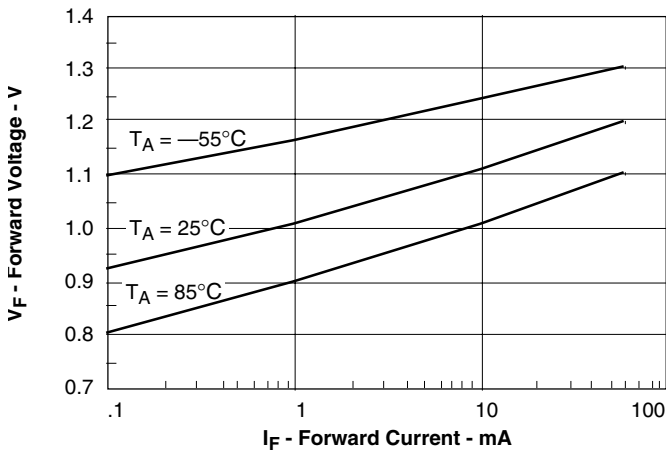

Figure 2. Normalized non-saturated and saturated CTR_{CE} vs. LED current

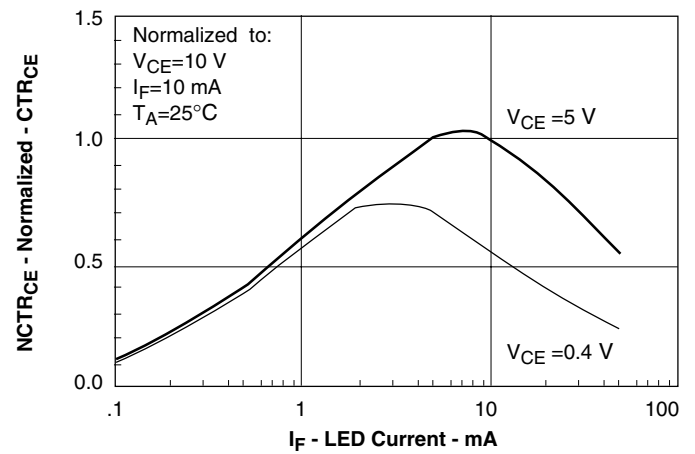

Figure 3. Collector-emitter current vs. LED current

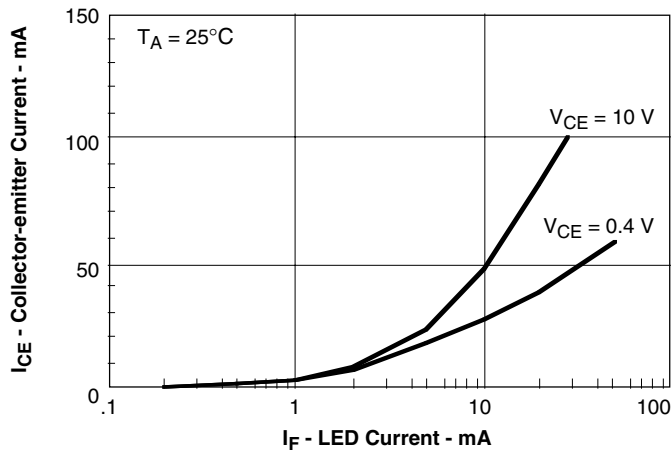

Figure 6. Collector-emitter photo current vs. LED current

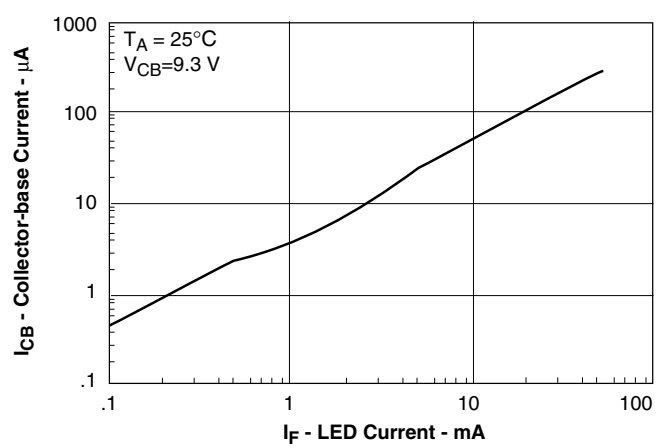

Figure 4. Normalized collector-base photo current vs. LED current

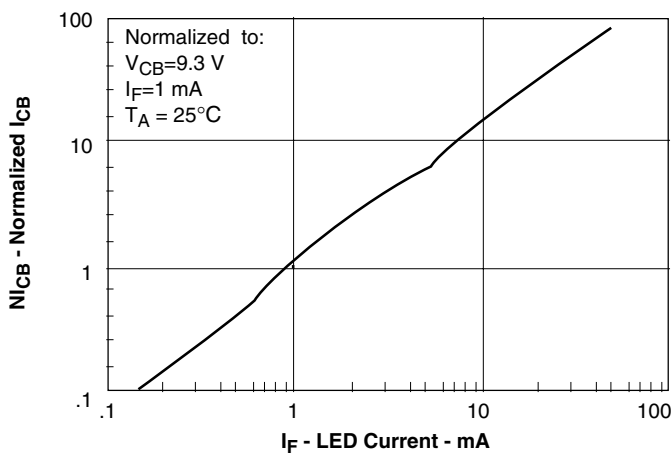

Figure 7. Collector-emitter photo current vs. LED current

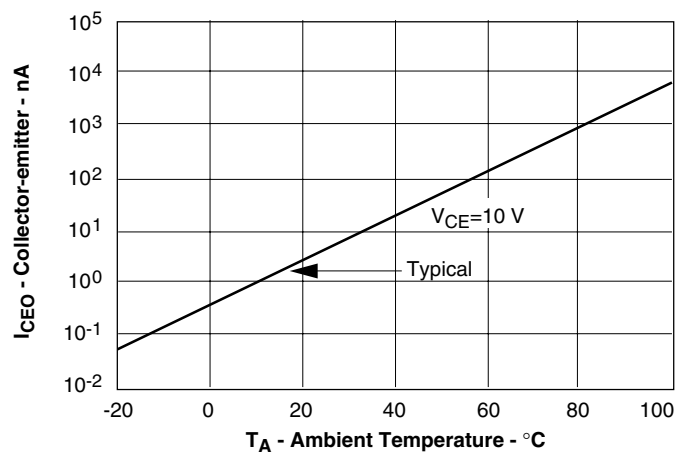

Figure 5. Normalized collector-base photo current vs. LED current

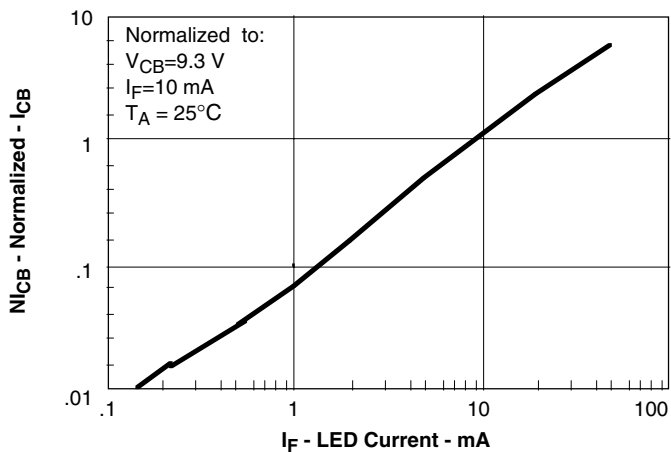

Figure 8. Base current vs. I_F and HFE

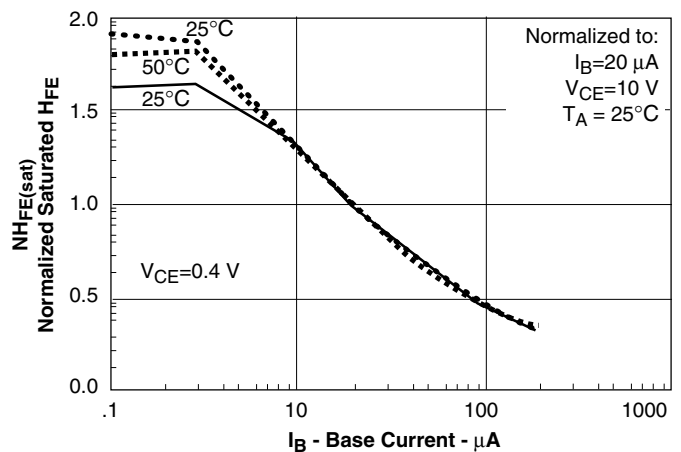

Figure 9. Typical switching characteristics vs. base resistance (saturated operation)

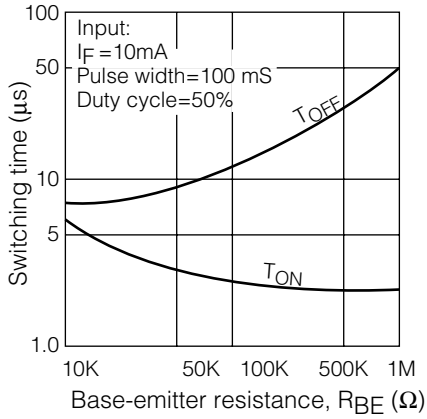

Figure 10. Typical switching times vs. load resistance

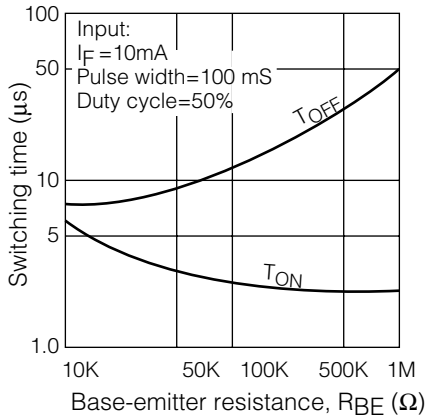

Figure 11. Switching time test schematic and waveform

