

# Fast Silicon Mesa Rectifiers

## Features

- Glass passivated junction
- Hermetically sealed package
- Low reverse current
- Soft recovery characteristics

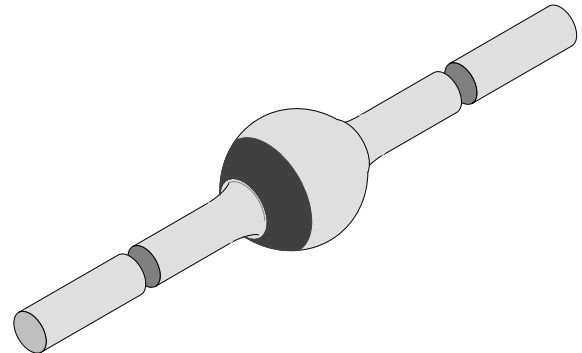

94 9588

## Applications

Fast rectifier and switch for example for TV-line output circuits and switch mode power supply

## Absolute Maximum Ratings

 $T_j = 25^\circ\text{C}$ 

| Parameter   | Test Conditions                     | Type  | Symbol          | Value      | Unit             |
|---|-------------------------------------|-------|-----------------|------------|------------------|
| Reverse voltage=<br>Repetitive peak reverse voltage |                                     | BYW72 | $V_R = V_{RRM}$ | 200        | V                |
|   |                                     | BYW73 |                 | 300        |                  |
|   |                                     | BYW74 |                 | 400        |                  |
|   |                                     | BYW75 |                 | 500        |                  |
|   |                                     | BYW76 |                 | 600        |                  |
| Peak forward surge current                          | $t_p = 10\text{ms}$ , half sinewave |       | $I_{FSM}$       | 100        | A                |
| Repetitive peak forward current                     |                                     |       | $I_{FRM}$       | 15         | A                |
| Average forward current                             |                                     |       | $I_{FAV}$       | 3          | A                |
| Junction and storage temperature range              |                                     |       | $T_j = T_{stg}$ | -65...+175 | $^\circ\text{C}$ |
| Non repetitive reverse avalanche energy             | $I_{(BR)R} = 0.4\text{A}$           |       | $E_R$           | 10         | mJ               |

## Maximum Thermal Resistance

 $T_j = 25^\circ\text{C}$ 

| Parameter        | Test Conditions                             | Symbol     | Value | Unit |
|------------------|---|------------|-------|------|
| Junction ambient | $l = 10\text{mm}$ , $T_L = \text{constant}$ | $R_{thJA}$ | 25    | K/W  |
|                  | on PC board with spacing 25mm               |            | 70    |      |

## Electrical Characteristics

 $T_j = 25^\circ\text{C}$ 

| Parameter             | Test Conditions  | Type | Symbol   | Min | Typ  | Max | Unit          |
|-----------------------|--|------|----------|-----|------|-----|---------------|
| Forward voltage       | $I_F = 3\text{A}$  |      | $V_F$    |     | 0.95 | 1.1 | V             |
| Reverse current       | $V_R = V_{RRM}$  |      | $I_R$    |     | 1    | 5   | $\mu\text{A}$ |
|                       | $V_R = V_{RRM}$ , $T_j = 150^\circ\text{C}$                    |      |          |     | 60   | 150 |               |
| Reverse recovery time | $I_F = 0.5\text{A}$ , $I_R = 1\text{A}$ , $i_R = 0.25\text{A}$ |      | $t_{rr}$ |     |      | 200 | ns            |

Characteristics ( $T_j = 25^\circ\text{C}$  unless otherwise specified)

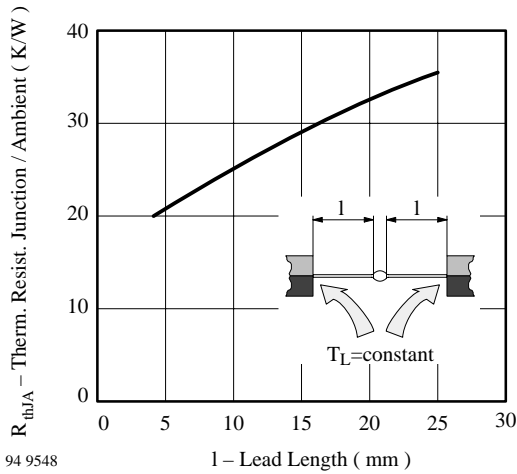

94 9548

Figure 1. Max. Thermal Resistance vs. Lead Length

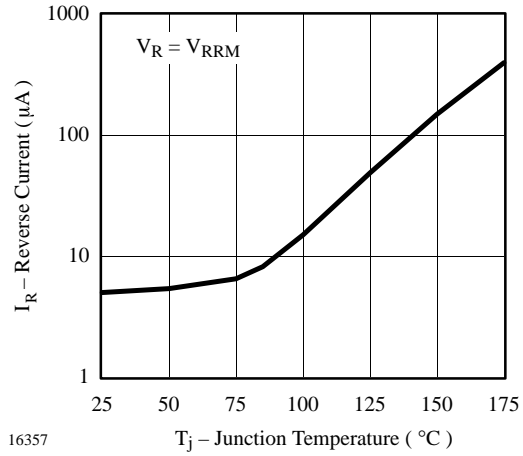

16357

Figure 4. Reverse Current vs. Junction Temperature

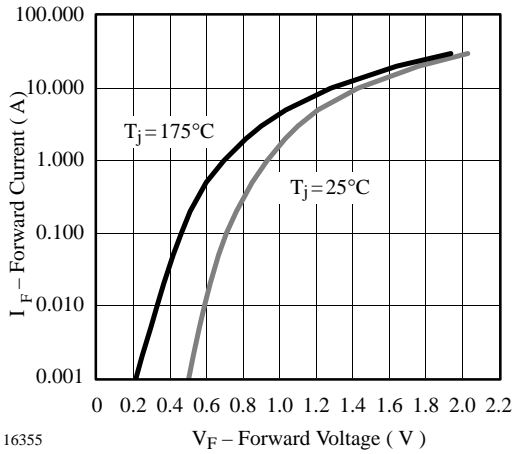

16355

Figure 2. Forward Current vs. Forward Voltage

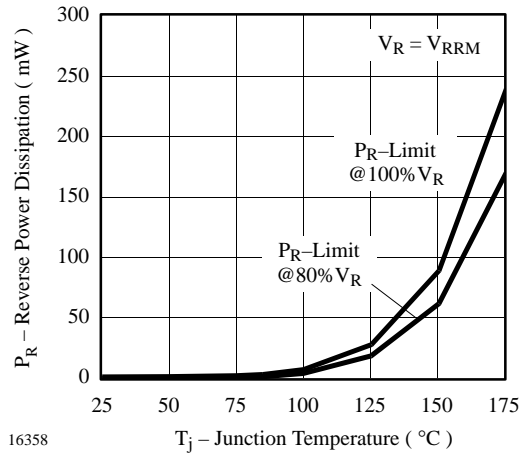

16358

Figure 5. Max. Reverse Power Dissipation vs. Junction Temperature

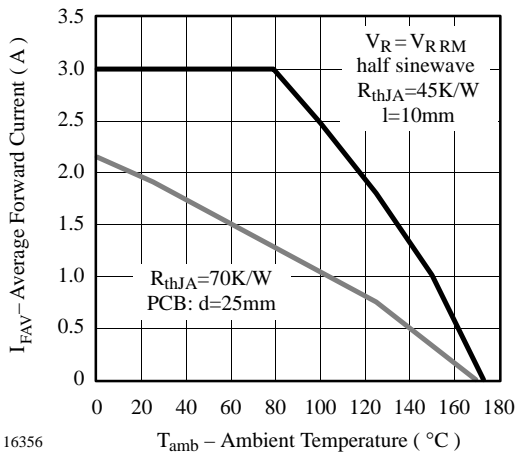

16356

Figure 3. Max. Average Forward Current vs. Ambient Temperature

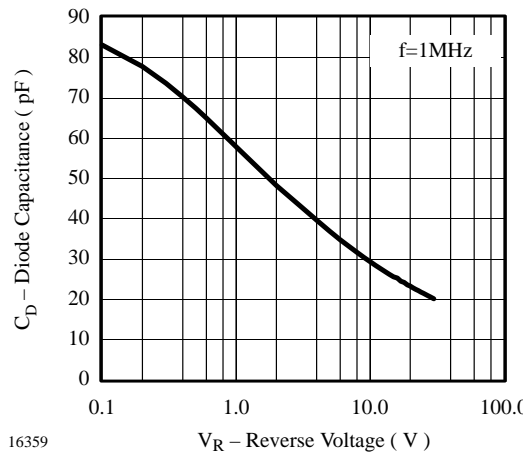

16359

Figure 6. Diode Capacitance vs. Reverse Voltage

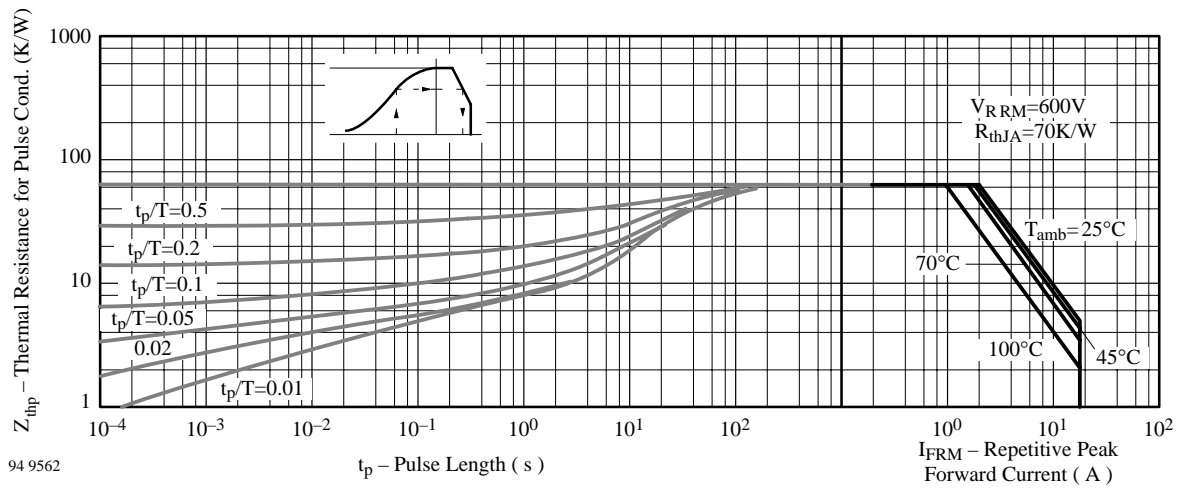
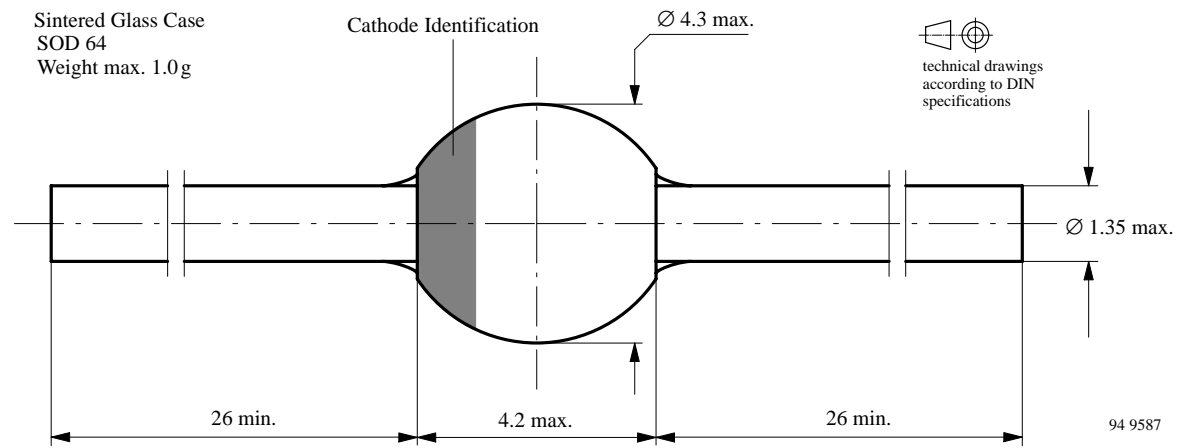

Figure 7. Thermal Response

### Dimensions in mm



### Ozone Depleting Substances Policy Statement

It is the policy of **Vishay Semiconductor GmbH** to

1. Meet all present and future national and international statutory requirements.
2. Regularly and continuously improve the performance of our products, processes, distribution and operating systems with respect to their impact on the health and safety of our employees and the public, as well as their impact on the environment.

It is particular concern to control or eliminate releases of those substances into the atmosphere which are known as ozone depleting substances (ODSs).

The Montreal Protocol (1987) and its London Amendments (1990) intend to severely restrict the use of ODSs and forbid their use within the next ten years. Various national and international initiatives are pressing for an earlier ban on these substances.

**Vishay Semiconductor GmbH** has been able to use its policy of continuous improvements to eliminate the use of ODSs listed in the following documents.

1. Annex A, B and list of transitional substances of the Montreal Protocol and the London Amendments respectively
2. Class I and II ozone depleting substances in the Clean Air Act Amendments of 1990 by the Environmental Protection Agency (EPA) in the USA
3. Council Decision 88/540/EEC and 91/690/EEC Annex A, B and C (transitional substances) respectively.

**Vishay Semiconductor GmbH** can certify that our semiconductors are not manufactured with ozone depleting substances and do not contain such substances.

**We reserve the right to make changes to improve technical design and may do so without further notice.**

Parameters can vary in different applications. All operating parameters must be validated for each customer application by the customer. Should the buyer use Vishay-Telefunken products for any unintended or unauthorized application, the buyer shall indemnify Vishay-Telefunken against all claims, costs, damages, and expenses, arising out of, directly or indirectly, any claim of personal damage, injury or death associated with such unintended or unauthorized use.

Vishay Semiconductor GmbH, P.O.B. 3535, D-74025 Heilbronn, Germany  
Telephone: 49 (0) 7131 67 2831, Fax number: 49 (0) 7131 67 2423