

Major Ratings and Characteristics

| Characteristics | MBR340 | Units |
|----------------------------------|------------|------------|
| $I_{F(AV)}$ Rectangular waveform | 3.0 | A |
| V_{RRM} | 30/40 | V |
| I_{FSM} @ $t_p = 5 \mu s$ sine | 430 | A |
| V_F @3Apk, $T_J = 25^\circ C$ | 0.6 | V |
| T_J | -40 to 150 | $^\circ C$ |

Description/Features

The MBR340 axial leaded Schottky rectifier has been optimized for very low forward voltage drop, with moderate leakage. Typical applications are in switching power supplies, converters, free-wheeling diodes, and reverse battery protection.

- Low profile, axial leaded outline
- High purity, high temperature epoxy encapsulation for enhanced mechanical strength and moisture resistance
- Very low forward voltage drop
- High frequency operation
- Guard ring for enhanced ruggedness and long term reliability

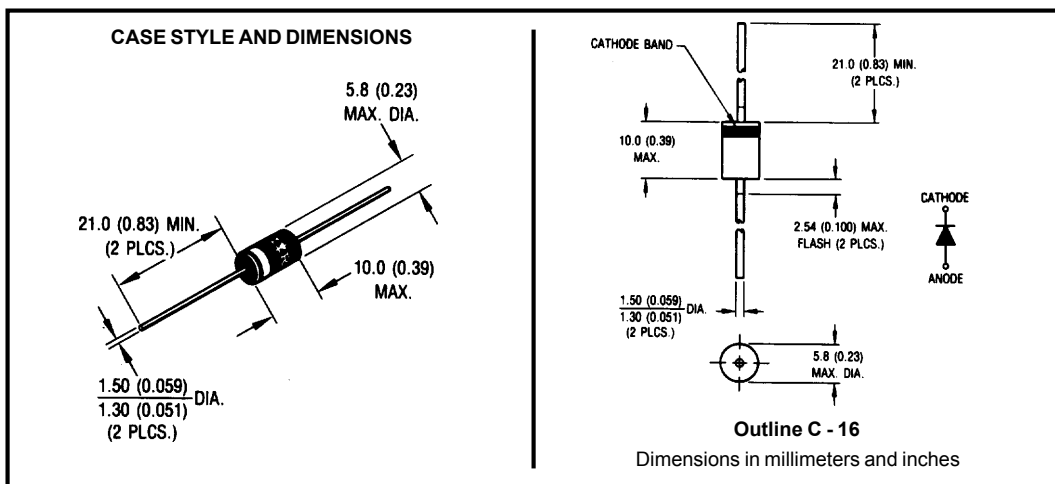

MBR340

Bulletin PD-20593 rev. A 03/02

International
IR Rectifier

Voltage Ratings

| Part number | MBR340 |
|---|--------|
| V_R Max. DC Reverse Voltage (V) | 40 |
| V_{RWM} Max. Working Peak Reverse Voltage (V) | |

Absolute Maximum Ratings

| Parameters | MBR340 | Units | Conditions |
|---|--------|-------|--|
| $I_{F(AV)}$ Max. Average Forward Current * See Fig. 4 | 3.0 | A | 50% duty cycle @ $T_C = 92^\circ\text{C}$, rectangular waveform |
| I_{FSM} Max. Peak One Cycle Non-Repetitive Surge Current * See Fig. 6 | 430 | A | 5 μs Sine or 3 μs Rect. pulse |
| | 80 | | 10ms Sine or 6ms Rect. pulse |
| E_{AS} Non-Repetitive Avalanche Energy | 8.0 | mJ | $T_J = 25^\circ\text{C}$, $I_{AS} = 1$ Amps, $L = 5$ mH |
| I_{AR} Repetitive Avalanche Current | 1.0 | A | Current decaying linearly to zero in 1 μsec Frequency limited by T_J max. $V_A = 1.5 \times V_R$ typical |

Electrical Specifications

| Parameters | MBR340 | Units | Conditions |
|---|--------|------------------|---|
| V_{FM} Max. Forward Voltage Drop * See Fig. 1 (1) | 0.5 | V | @ 1.0A |
| | 0.6 | V | @ 3.0A |
| | 0.85 | V | @ 9.4A |
| | 0.37 | V | @ 1.0A |
| | 0.49 | V | @ 3.0A |
| | 0.72 | V | @ 9.4A |
| I_{RM} Max. Reverse Leakage Current * See Fig. 2 (1) | 0.6 | mA | $T_J = 25^\circ\text{C}$ |
| | 8 | mA | $T_J = 100^\circ\text{C}$ |
| | 20 | mA | $T_J = 125^\circ\text{C}$ |
| C_T Typical Junction Capacitance | 190 | pF | $V_R = 5V_{DC}$ (test signal range 100Khz to 1Mhz) 25°C |
| L_S Typical Series Inductance | 9.0 | nH | Measured lead to lead 5mm from package body |
| dv/dt Max. Voltage Rate of Change | 10000 | V/ μs | (Rated V_R) |

(1) Pulse Width < 300 μs , Duty Cycle < 2%

Thermal-Mechanical Specifications

| Parameters | MBR340 | Units | Conditions |
|---|------------|--------------------|-----------------------------|
| T_J Max. Junction Temperature Range (*) | -40 to 150 | $^\circ\text{C}$ | |
| T_{stg} Max. Storage Temperature Range | -40 to 150 | $^\circ\text{C}$ | |
| R_{thJL} Typical Thermal Resistance Junction to Lead (**) | 28 | $^\circ\text{C/W}$ | DC operation (* See Fig. 4) |
| wt Approximate Weight | 1.2(0.042) | g(oz.) | |
| Case Style | C-16 | | |

(*) $\frac{dP_{tot}}{dT_J} < \frac{1}{R_{th(j-a)}}$ thermal runaway condition for a diode on its own heatsink

(**) Mounted 1 inch square PCB, thermal probe connected to lead 2mm from package

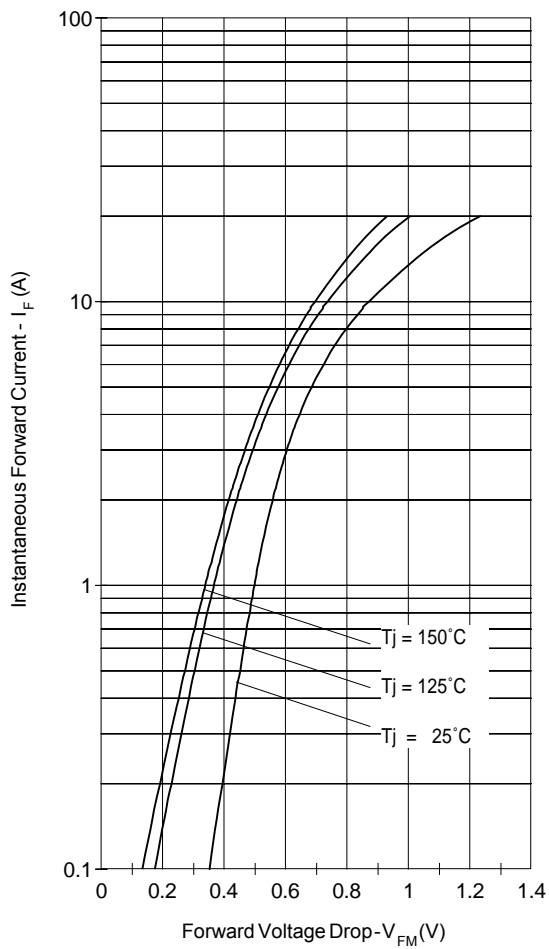

Fig. 1 - Max. Forward Voltage Drop Characteristics

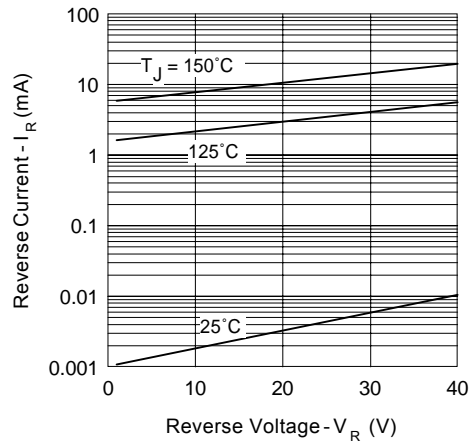

Fig. 2 - Typical Values Of Reverse Current Vs. Reverse Voltage

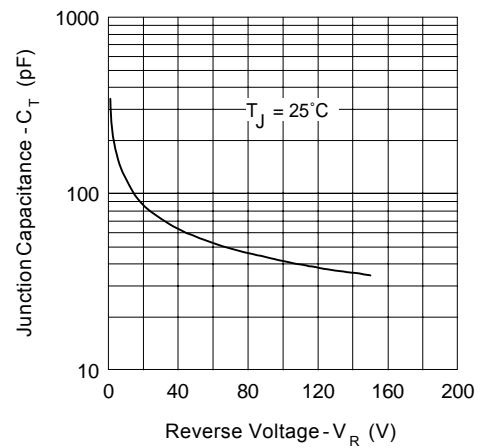

Fig. 3 - Typical Junction Capacitance Vs. Reverse Voltage

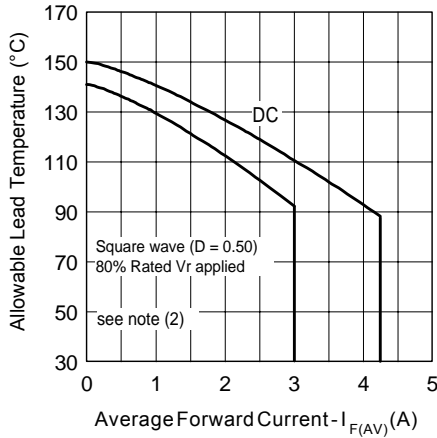

Fig. 4 - Max. Allowable Lead Temperature Vs. Average Forward Current

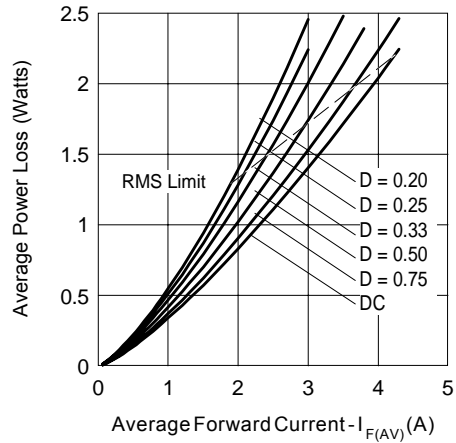

Fig. 5-Forward Power Loss Characteristics

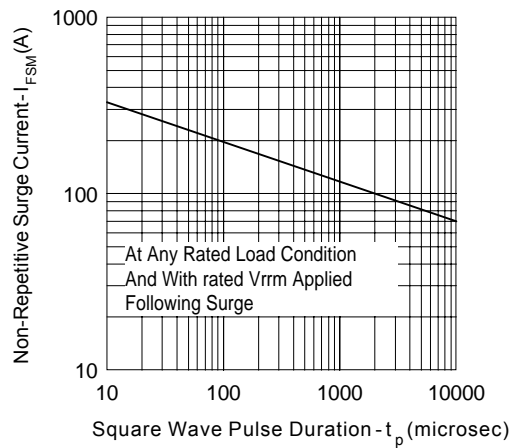

Fig. 6 - Max. Non-Repetitive Surge Current

(2) Formula used: $T_C = T_J - (Pd + Pd_{REV}) \times R_{thJC}$;

$Pd = \text{Forward Power Loss} = I_{F(AV)} \times V_{FM} @ (I_{F(AV)} / D)$ (see Fig. 6);

$Pd_{REV} = \text{Inverse Power Loss} = V_{R1} \times I_R (1 - D)$; $I_R @ V_{R1} = 80\% \text{ rated } V_R$

Ordering Information Table

| | | | | |
|--------------------|------------|-------------------------------------|-----------|-----------|
| Device Code | MBR | 3 | 40 | TR |
| | ① | ② | ③ | ④ |
| 1 | - | Schottky MBR Series | | |
| 2 | - | Current Rating: 3 = 3A | | |
| 3 | - | Voltage Rating: 40 = 40V | | |
| 4 | - | TR = Tape & Reel package (1200 pcs) | | |
| | - | = Box package (500 pcs) | | |

Data and specifications subject to change without notice.
This product has been designed and qualified for Industrial Level.
Qualification Standards can be found on IR's Web site.

International
IR Rectifier

IR WORLD HEADQUARTERS: 233 Kansas St., El Segundo, California 90245, USA Tel: (310) 252-7105
TAC Fax: (310) 252-7309
Visit us at www.irf.com for sales contact information. 03/02