

LM2904, LM358/LM358A, LM258/ LM258A

Dual Operational Amplifier

Features

- Internally frequency compensated for unity gain
- Large DC voltage gain: 100dB
- Wide power supply range:
LM258/LM258A, LM358/LM358A: 3V~32V (or $\pm 1.5V\sim 16V$)
LM2904 : 3V~26V (or $\pm 1.5V\sim 13V$)
- Input common mode voltage range Includes ground
- Large output voltage swing: 0V DC to $V_{cc} - 1.5V$ DC
- Power drain suitable for battery operation.

Description

The LM2904, LM358/LM358A, LM258/LM258A consist of two independent, high gain, internally frequency compensated operational amplifiers which were designed specifically to operate from a single power supply over a wide range of voltage. Operation from split power supplies is also possible and the low power supply current drain is independent of the magnitude of the power supply voltage. Application areas include transducer amplifier, DC gain blocks and all the conventional OP amp circuits which now can be easily implemented in single power supply systems.

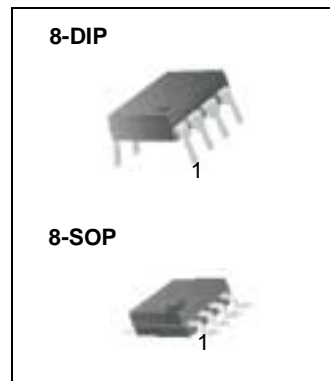

Internal Block Diagram

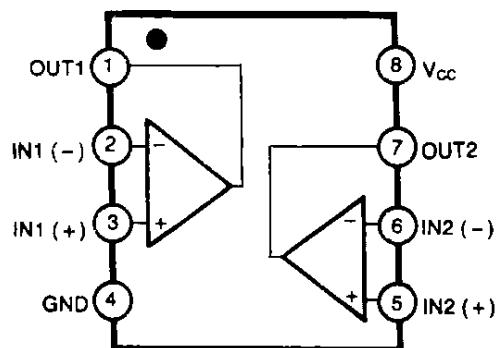

Schematic Diagram

(One section only)

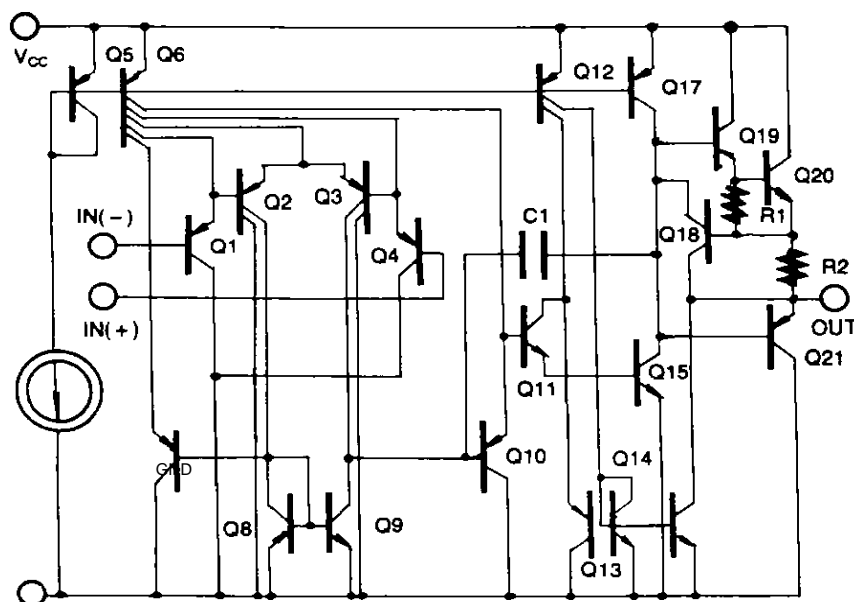

Absolute Maximum Ratings

Parameter	Symbol	LM258/LM258A	LM358/LM358A	LM2904	Unit
Supply Voltage	V _{CC}	±16 or 32	±16 or 32	±13 or 26	V
Differential Input Voltage	V _{I(DIFF)}	32	32	26	V
Input Voltage	V _I	-0.3 to +32	-0.3 to +32	-0.3 to +26	V
Output Short Circuit to GND V _{CC} ≤ 15V, T _A = 25 °C (One Amp)	-	Continuous	Continuous	Continuous	-
Operating Temperature Range	T _{OPR}	-25 ~ + 85	0 ~ + 70	-40 ~ + 85	°C
Storage Temperature Range	T _{STG}	-65 ~ + 150	-65 ~ + 150	-65 ~ + 150	°C

Electrical Characteristics

($V_{CC} = 5.0V$, $V_{EE} = GND$, $T = 25\text{ }^{\circ}C$, unless otherwise specified)

Parameter	Symbol	Conditions	LM258			LM358			LM2904			Unit
			Min.	Typ.	Max.	Min.	Typ.	Max.	Min.	Typ.	Max.	
Input Offset Voltage	V_{IO}	$V_{CM} = 0V$ to $V_{CC} - 1.5V$ $V_{O(P)} = 1.4V$, $R_S = 0\Omega$	-	2.9	5.0	-	2.9	7.0	-	2.9	7.0	mV
Input Offset Current	I_{IO}	-	-	3	30	-	5	50	-	5	50	nA
Input Bias Current	I_{BIAS}	-	-	45	150	-	45	250	-	45	250	nA
Input Voltage Range	$V_{I(R)}$	$V_{CC} = 30V$ (LM2904, $V_{CC} = 26V$)	0	-	$V_{CC} - 1.5$	0	-	$V_{CC} - 1.5$	0	-	$V_{CC} - 1.5$	V
Supply Current	I_{CC}	$R_L = \infty$, $V_{CC} = 30V$ (LM2904, $V_{CC} = 26V$)	-	0.8	2.0	-	0.8	2.0	-	0.8	2.0	mA
		$R_L = \infty$, over full temperature range	-	0.5	1.2	-	0.5	1.2	-	0.5	1.2	mA
Large Signal Voltage Gain	G_V	$V_{CC} = 15V$, $R_L \geq 2K\Omega$ $V_{O(P)} = 1V$ to $11V$	50	100	-	25	100	-	25	100	-	V/mV
Output Voltage Swing	$V_{O(H)}$	$V_{CC} = 30V$ $R_L = 2K\Omega$	26	-	-	26	-	-	22	-	-	V
	$V_{O(L)}$	$V_{CC} = 26V$ for LM2904 $R_L = 10K\Omega$	27	28	-	27	28	-	23	24	-	V
		$V_{CC} = 5V$, $R_L \geq 10K\Omega$	-	5	20	-	5	20		5	100	mV
Common-Mode Rejection Ratio	CMRR	-	70	85	-	65	80	-	50	80	-	dB
Power Supply Rejection Ratio	PSRR	-	65	100	-	65	100	-	50	100	-	dB
Channel Separation	CS	$f = 1KHz$ to $20KHz$	-	120	-	-	120	-	-	120	-	dB
Short Circuit to GND	ISC	-	-	40	60	-	40	60	-	40	60	mA
Output Current	ISOURCE	$V_{I(+)} = 1V$, $V_{I(-)} = 0V$ $V_{CC} = 15V$, $V_{O(P)} = 2V$	10	30	-	10	30	-	10	30	-	mA
	ISINK	$V_{I(+)} = 0V$, $V_{I(-)} = 1V$, $V_{CC} = 15V$, $V_{O(P)} = 2V$	10	15	-	10	15	-	10	15	-	mA
		$V_{I(+)} = 0V$, $V_{I(-)} = 1V$, $V_{CC} = 15V$, $V_{O(P)} = 200mV$	12	100	-	12	100	-	-	-	-	μA
Differential Input Voltage	$V_{I(DIFF)}$	-	-	V_{CC}	-	-	V_{CC}	-	-	V_{CC}	V	

Electrical Characteristics

($V_{CC}=5.0V$, $V_{EE}=GND$, unless otherwise specified)

The following specifications apply over the range of $-25\text{ }^{\circ}\text{C} \leq T_A \leq +85\text{ }^{\circ}\text{C}$ for the LM258; and the $0\text{ }^{\circ}\text{C} \leq T_A \leq +70\text{ }^{\circ}\text{C}$ for the LM358; and the $-40\text{ }^{\circ}\text{C} \leq T_A \leq +85\text{ }^{\circ}\text{C}$ for the LM2904

Parameter	Symbol	Conditions	LM258			LM358			LM2904			Unit
			Min.	Typ.	Max.	Min.	Typ.	Max.	Min.	Typ.	Max.	
Input Offset Voltage	V_{IO}	$V_{CM} = 0V$ to $V_{CC} - 1.5V$ $V_{O(P)} = 1.4V$, $R_S = 0\Omega$	-	-	7.0	-	-	9.0	-	-	10.0	mV
Input Offset Voltage Drift	$\Delta V_{IO}/\Delta T$	$R_S = 0\Omega$	-	7.0	-	-	7.0	-	-	7.0	-	$\mu V/^{\circ}\text{C}$
Input Offset Current	I_{IO}	-	-	-	100	-	-	150	-	45	200	nA
Input Offset Current Drift	$\Delta I_{IO}/\Delta T$	-	-	10	-	-	10	-	-	10	-	$\text{pA}/^{\circ}\text{C}$
Input Bias Current	I_{BIAS}	-	-	40	300	-	40	500	-	40	500	nA
Input Voltage Range	$V_{I(R)}$	$V_{CC} = 30V$ (LM2904, $V_{CC} = 26V$)	0	-	$V_{CC} - 2.0$	0	-	$V_{CC} - 2.0$	0	-	$V_{CC} - 2.0$	V
Large Signal Voltage Gain	G_V	$V_{CC} = 15V$, $R_L \geq 2.0K\Omega$ $V_{O(P)} = 1V$ to $11V$	25	-	-	15	-	-	15	-	-	V/mV
Output Voltage Swing	$V_{O(H)}$	$V_{CC} = 30V$, $R_L = 2K\Omega$	26	-	-	26	-	-	26	-	-	V
		$V_{CC} = 26V$ for LM2904, $R_L = 10K\Omega$	27	28	-	27	28	-	27	28	-	V
	$V_{O(L)}$	$V_{CC} = 5V$, $R_L \geq 10K\Omega$	-	5	20	-	5	20	-	5	20	mV
Output Current	I_{SOURCE}	$V_{I(+)} = 1V$, $V_{I(-)} = 0V$ $V_{CC} = 15V$, $V_{O(P)} = 2V$	10	30	-	10	30	-	10	30	-	mA
	I_{SINK}	$V_{I(+)} = 0V$, $V_{I(-)} = 1V$ $V_{CC} = 15V$, $V_{O(P)} = 2V$	5	8	-	5	9	-	5	9	-	mA
Differential Input Voltage	$V_{I(DIFF)}$	-	-	-	V_{CC}	-	-	V_{CC}	-	-	V_{CC}	V

Electrical Characteristics

(VCC = 5.0V. VEE=GND. TA=25 °C, unless otherwise specified)

Parameter	Symbol	Conditions	LM258A			LM358A			Unit
			Min.	Typ.	Max.	Min.	Typ.	Max.	
Input Offset Voltage	V _{IO}	V _{CM} = 0V to V _{CC} -1.5V V _{O(P)} = 1.4V, R _S = 0Ω	-	1.0	3.0	-	2.0	3.0	mV
Input Offset Current	I _{IO}	-	-	2	15	-	5	30	nA
Input Bias Current	I _{BIAS}	-	-	40	80	-	45	100	nA
Input Voltage Range	V _{I(R)}	V _{CC} = 30V	0	-	V _{CC} -1.5	0	-	V _{CC} -1.5	V
Supply Current	I _{CC}	R _L = ∞, V _{CC} = 30V	-	0.8	2.0	-	0.8	2.0	mA
		R _L = ∞, over full temperature range	-	0.5	1.2	-	0.5	1.2	mA
Large Signal Voltage Gain	G _V	V _{CC} = 15V, R _L ≥ 2KΩ V _O = 1V to 11V	50	100	-	25	100	-	V/mV
Output Voltage Swing	V _{OH}	V _{CC} = 30V	R _L = 2KΩ	26	-	-	26	-	V
			R _L = 10KΩ	27	28	-	27	28	-
	V _{OL}	V _{CC} = 5V, R _L ≥ 10KΩ	-	5	20	-	5	20	mV
Common-Mode Rejection Ratio	CMRR	-	70	85	-	65	85	-	dB
Power Supply Rejection Ratio	PSRR	-	65	100	-	65	100	-	dB
Channel Separation	CS	f = 1KHz to 20KHz	-	120	-	-	120	-	dB
Short Circuit to GND	I _{SC}	-	-	40	60	-	40	60	mA
Output Current	I _{SOURCE}	V _{I(+)} = 1V, V _{I(-)} = 0V V _{CC} = 15V, V _{O(P)} = 2V	20	30	-	20	30	-	mA
		V _{I(+)} = 1V, V _{I(-)} = 0V V _{CC} = 15V, V _{O(P)} = 2V	10	15	-	10	15	-	mA
	I _{SINK}	V _{in +} = 0V, V _{in -} = 1V V _{O(P)} = 200mV	12	100	-	12	100	-	μA
Differential Input Voltage	V _{I(DIFF)}	-	-	-	V _{CC}	-	-	V _{CC}	V

Electrical Characteristics

($V_{CC} = 5.0V$, $V_{EE} = GND$. unless otherwise specified)

The following specifications apply over the range of $-25^{\circ}C \leq T_A \leq +85^{\circ}C$ for the LM258A; and the $0^{\circ}C \leq T_A \leq +70^{\circ}C$ for the LM358A

Parameter	Symbol	Conditions	LM258A			LM358A			Unit
			Min.	Typ.	Max.	Min.	Typ.	Max.	
Input Offset Voltage	V_{IO}	$V_{CM} = 0V$ to $V_{CC} - 1.5V$ $V_{O(P)} = 1.4V$, $R_S = 0\Omega$	-	-	4.0	-	-	5.0	mV
Input Offset Voltage Drift	$\Delta V_{IO}/\Delta T$	-	-	7.0	15	-	7.0	20	$\mu V/^{\circ}C$
Input Offset Current	I_{IO}	-	-	-	30	-	-	75	nA
Input Offset Current Drift	$\Delta I_{IO}/\Delta T$	-	-	10	200	-	10	300	$pA/^{\circ}C$
Input Bias Current	I_{BIAS}	-	-	40	100	-	40	200	nA
Input Common-Mode Voltage Range	$V_{I(R)}$	$V_{CC} = 30V$	0	-	$V_{CC} - 2.0$	0	-	$V_{CC} - 2.0$	V
Output Voltage Swing	$V_{O(H)}$	$V_{CC} = 30V$, $R_L = 2K\Omega$	26	-	-	26	-	-	V
		$V_{CC} = 30V$, $R_L = 10K\Omega$	27	28	-	27	28	-	V
	$V_{O(L)}$	$V_{CC} = 5V$, $R_L \geq 10K\Omega$	-	5	20	-	5	20	mV
Large Signal Voltage Gain	G_V	$V_{CC} = 15V$, $R_L \geq 2.0K\Omega$ $V_{O(P)} = 1V$ to $11V$	25	-	-	15	-	-	V/mV
Output Current	I_{SOURCE}	$V_{I(+)} = 1V$, $V_{I(-)} = 0V$ $V_{CC} = 15V$, $V_{O(P)} = 2V$	10	30	-	10	30	-	mA
	I_{SINK}	$V_{I(+)} = 1V$, $V_{I(-)} = 0V$ $V_{CC} = 15V$, $V_{O(P)} = 2V$	5	9	-	5	9	-	mA
Differential Input Voltage	$V_{I(DIFF)}$	-	-	-	V_{CC}	-	-	V_{CC}	V

Typical Performance Characteristics

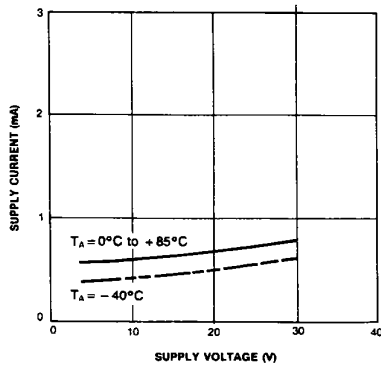

Figure 1. Supply Current vs Supply Voltage

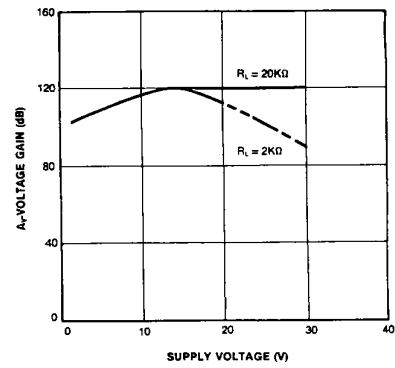

Figure 2. Voltage Gain vs Supply Voltage

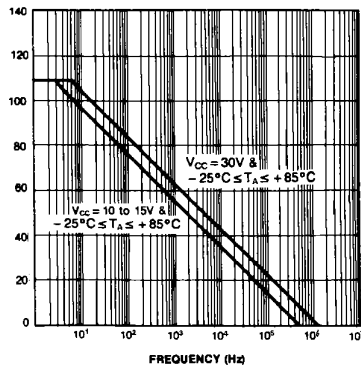

Figure 3. Open Loop Frequency Response

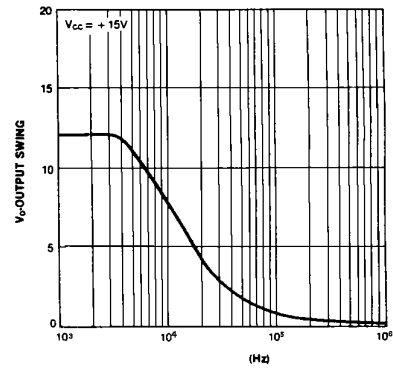

Figure 4. Large Signal Output Swing vs Frequency

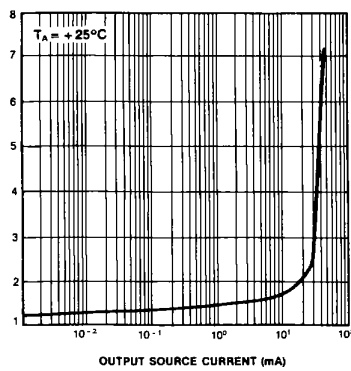

Figure 5. Output Characteristics vs Current Sourcing

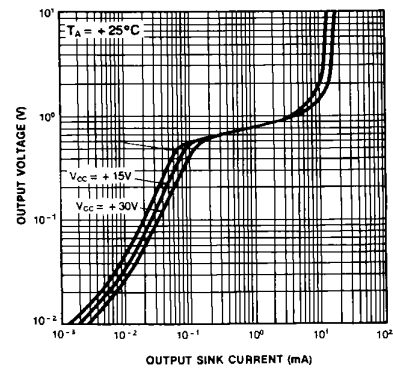

Figure 6. Output Characteristics vs Current Sinking

Typical Performance Characteristics (continued)

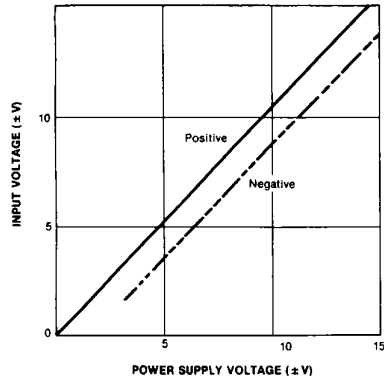

Figure 7. Input Voltage Range vs Supply Voltage

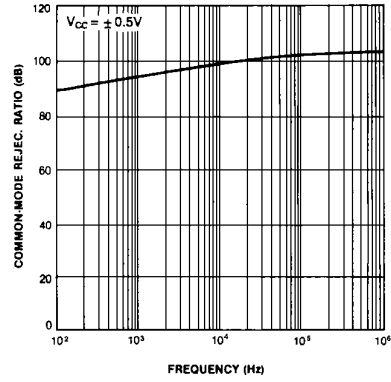

Figure 8. Common-Mode Rejection Ratio

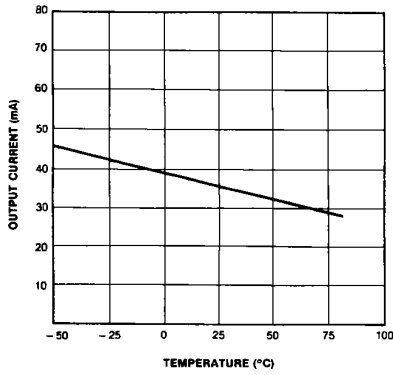

Figure 9. Current Limiting vs Temperature

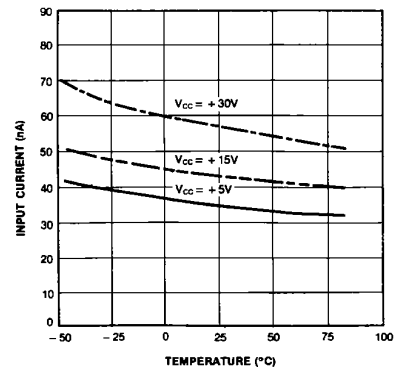

Figure 10. Input Current vs Temperature

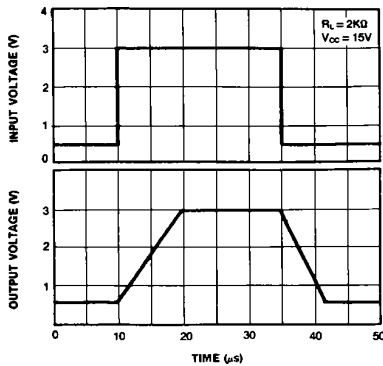

Figure 11. Voltage Follower Pulse Response

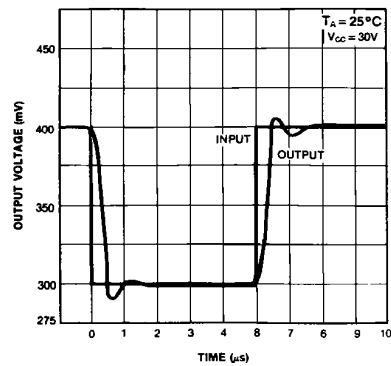
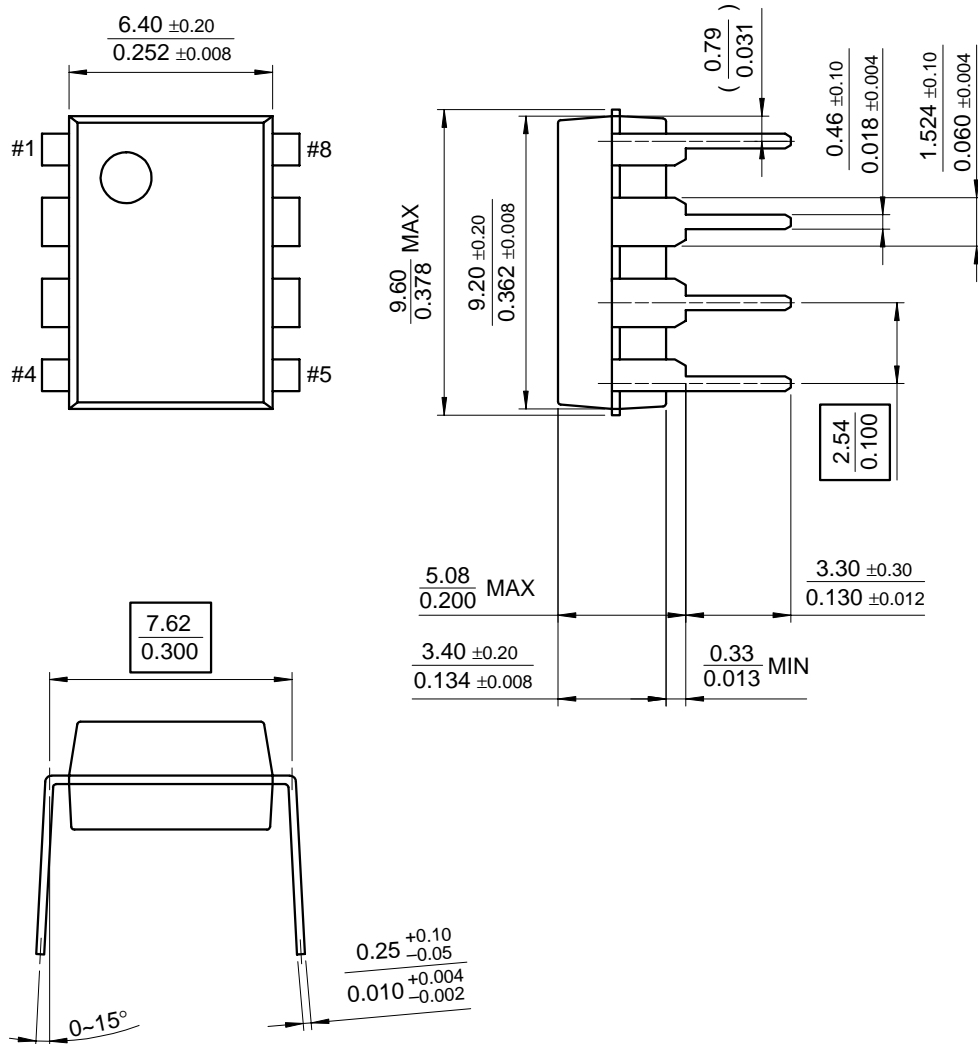

Figure 12. Voltage Follower Pulse Response (Small Signal)

Mechanical Dimensions

Package

8-DIP



Mechanical Dimensions (Continued)

Package

8-SOP

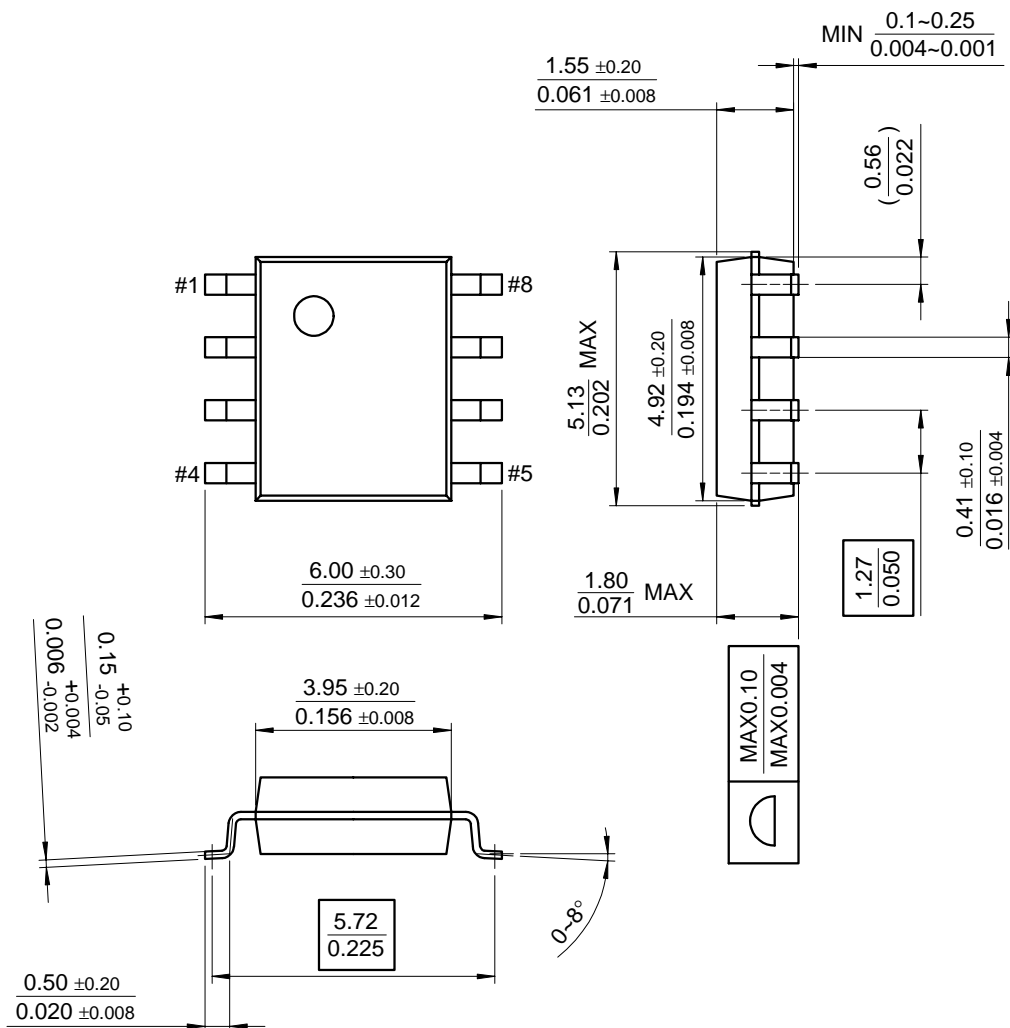

Ordering Information

Product Number	Package	Operating Temperature
LM358N	8-DIP	0 ~ + 70°C
LM358AN		
LM358M	8-SOP	
LM358AM		
LM2904N	8-DIP	-40 ~ + 85 °C
LM2904M	8-SOP	
LM258N	8-DIP	-25 ~ +85°C
LM258AN		
LM258M	8-SOP	
LM258AM		

DISCLAIMER

FAIRCHILD SEMICONDUCTOR RESERVES THE RIGHT TO MAKE CHANGES WITHOUT FURTHER NOTICE TO ANY PRODUCTS HEREIN TO IMPROVE RELIABILITY, FUNCTION OR DESIGN. FAIRCHILD DOES NOT ASSUME ANY LIABILITY ARISING OUT OF THE APPLICATION OR USE OF ANY PRODUCT OR CIRCUIT DESCRIBED HEREIN; NEITHER DOES IT CONVEY ANY LICENSE UNDER ITS PATENT RIGHTS, NOR THE RIGHTS OF OTHERS.

LIFE SUPPORT POLICY

FAIRCHILD'S PRODUCTS ARE NOT AUTHORIZED FOR USE AS CRITICAL COMPONENTS IN LIFE SUPPORT DEVICES OR SYSTEMS WITHOUT THE EXPRESS WRITTEN APPROVAL OF THE PRESIDENT OF FAIRCHILD SEMICONDUCTOR CORPORATION. As used herein:

1. Life support devices or systems are devices or systems which, (a) are intended for surgical implant into the body, or (b) support or sustain life, and (c) whose failure to perform when properly used in accordance with instructions for use provided in the labeling, can be reasonably expected to result in a significant injury of the user.
2. A critical component in any component of a life support device or system whose failure to perform can be reasonably expected to cause the failure of the life support device or system, or to affect its safety or effectiveness.